

Cervico System

Clinical Protocol of Use



VP INNOVATO HOLDINGS



Table of Contents

Consultation Stage	3
Surgical Stage	8
Impression Stage	15
Duplication Stage	19
Immediate Loading	25

The Clinical protocols proposed in this article are the result of extensive testing and have been proven to be the most effective.

VP Innovato Holdings offers extensive training on the use of the Cervico system/concept.





VP INNOVATO HOLDINGS

Consultation Stage



Step 1

Evaluate the mesio-distal dimension of the edentulous space



The evaluation of the mesio-distal dimension is important for you to be able to identify if the space is adequate in order to safely place an implant.

This dimension also relates to the maximum implant platform diameter that can be safely placed without violating the dangerous zone; Meaning the implant platform will have a safe inter-proximal distance of at least 1.5mm from the adjacent teeth.

Implant Platform diameters that can be safely utilised according to available mesio-distal space

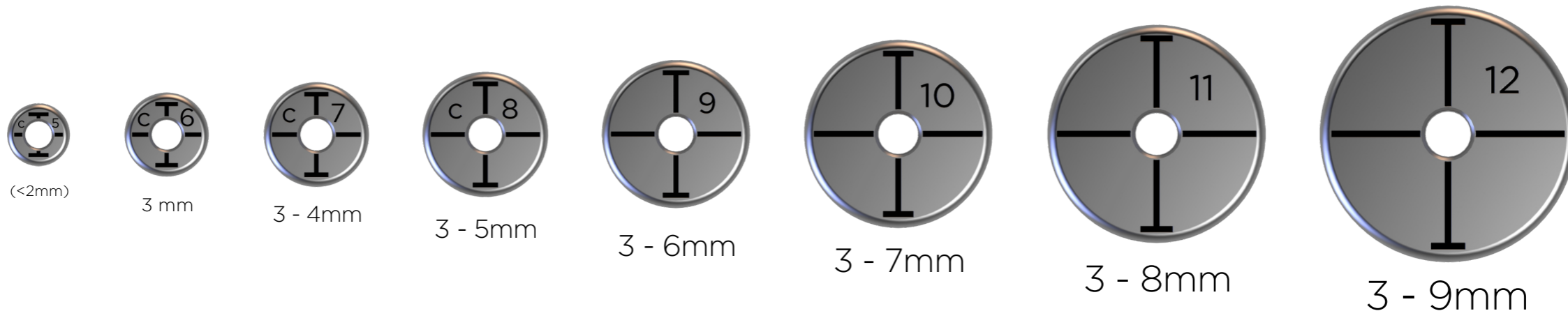

Step 2

Identify the dimensions and shape of the ideal gingival cervical profile (Custom healing abutment)⁵



Utilise the anatomical shape tab from the same group as per the tooth missing (E.g Premolar).

You can utilise alternatively the three different sizes (Small, Medium Large) until you identify the best suitable size. The ideal size is the one with same dimension buccolingually to the one of the crown to be placed (Thick soft tissue biotype), or one size smaller (Thin Soft Tissue Biotype).

Put a note in the patient's chart of the selected tab (E.g pS)

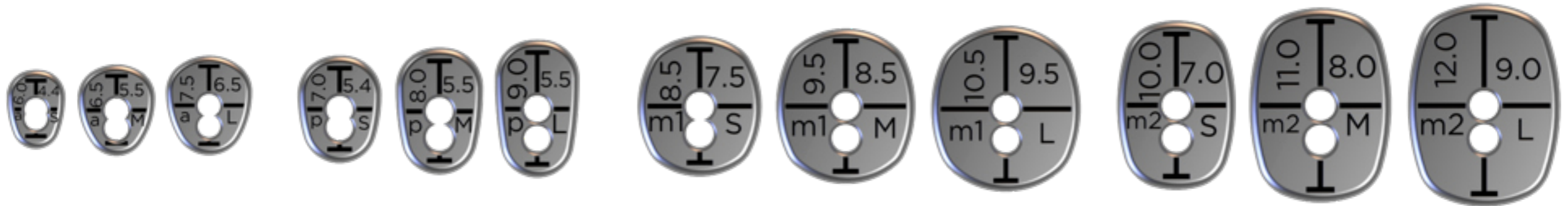

Anteriors

Premolars

Square molars

Elongated molars

Step 2

Identify the dimensions and shape of the ideal gingival cervical profile
(Custom healing abutment)

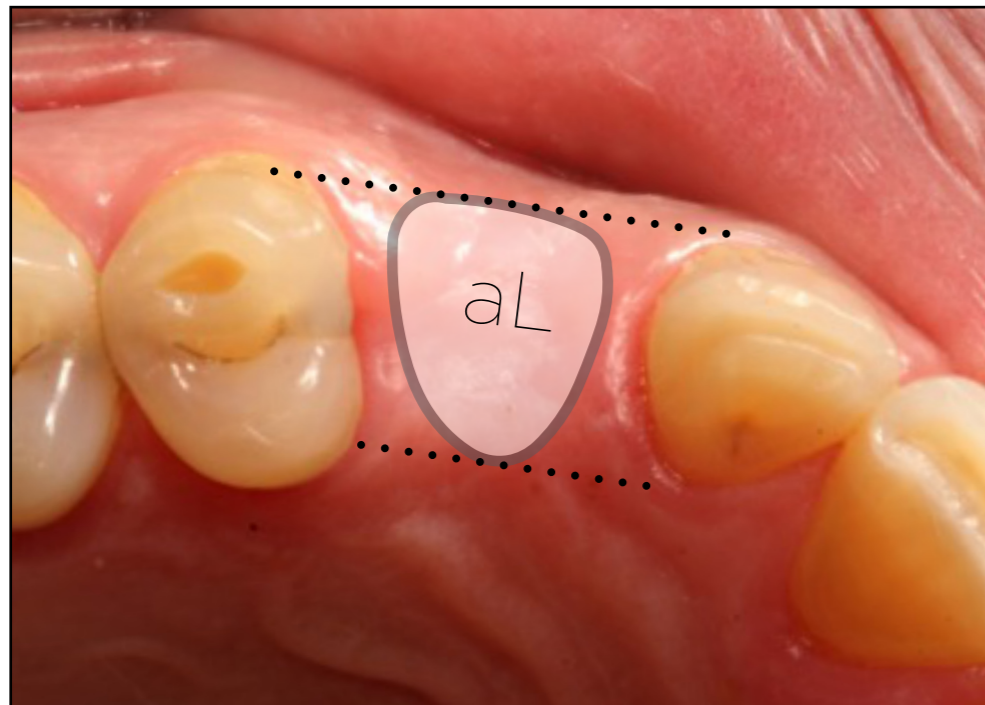

(a)

Thick Soft Tissue Biotype (a)

Chose a size with dimensions equal to the ones of the cervical portion of the future prosthesis



(b)

Thin Soft Tissue Biotype (b)

Chose a size with dimensions smaller to the ones of the cervical portion of the future prosthesis

Step 3

Identify the proper orientation of the prosthetic connection of the implant to be placed



The T-Line imprinted on the anatomical shape tab provides you the information on how the prosthetic connection of your implant should be oriented in space. This will ensure that the custom healing abutment will be oriented in space, once coupled to the implant, with the same orientation as to the one depicted by the guide.

Please refer to the document “Guide-Prosthetic connection orientation” for detailed information on proper prosthetic connection orientation per implant brand.



Hexagon



Octagon



Trilobe



Cams





VP INNOVATO HOLDINGS

Surgical Stage



Step 1

Utilise the cylindrical tab in order to drill through and center your osteotomy in the edentulous space



The desired cylindrical tab has already been depicted at the consultation appointment; And the ideal tab is the one that best fits the edentulous space being in light contact with the adjacent teeth. In case the adjacent tooth is absent, then the ideal is the one with dimensions resembling the mesio-distal dimension of the tooth to be replaced.

Align the central line imprinted on the top surface of the tab to the occlusal lines of the adjacent teeth.

Drill through the central open bore utilising a pilot drill (<2.1mm diameter) in order to mark the entry point of your osteotomy.

This process is advisable to be done prior to flap reflection as this makes easier the process of tab alignment in space.

Step 2

Evaluate the osteotomy position and inclination in relation to the desired to be generated cervical profile



Insert the surgical pin of the guide into the osteotomy and then install the selected anatomical shape tab.

The desired anatomical tab has already been depicted at the consultation appointment.

You can now picture the custom healing abutment to be used and its relationship to the edentulous space. Since the tab carries two open bores, it can be installed onto the pin in two different positions, a centered and an off-centered*.

The position and angulation of your osteotomy in relation to the desired to be generated cervical profile is now easily evaluated and any necessary adjustments can be made at the subsequent drilling steps.

*If the ideal placement of the tab is related to centered installation on the pin, then the centered silicone insert should be used when fabricating the custom healing abutment with the Cervico Mold. If the ideal placement of the tab is related to off-centered installation on the pin, then the off-centered silicone insert should be used when fabricating the custom healing abutment

This process is advisable to be done for every step of drilling in order to ensure full control of your osteotomy's position and angulation throughout the whole process of osteotomy preparation. For the above purpose the system provides you with four different size pins that correspond to different size drills.

Step 3 Custom Healing Abutment Fabrication Process

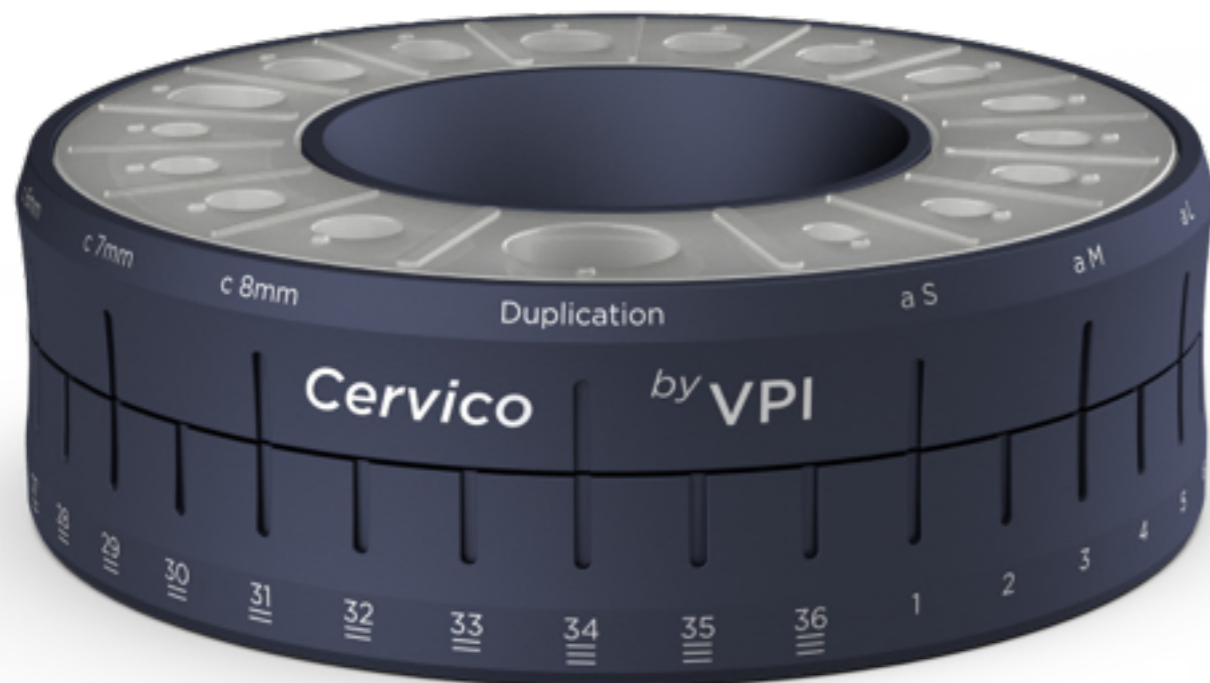

Rotate the top ring of the mold until the desired shape/size silicone well is aligned to the desired VPI Prosthetic Connection Insert present in the base of the mold.

This is a process that can and should be carried out by your assistant.

 PROSTHETIC CONNECTION DATA BASE				
Mold Position	Implant Company	Implant Name	Platform Size	VPI Insert Item Number
1	NobelBiocare	Replace	NP	5213006650369
2	NobelBiocare	Replace	RP/WP	5213006650376
15	NobelBiocare	Active	NP	5213006650338
16	NobelBiocare	Active	RP	5213006650345

The position of each of the VPI Prosthetic Connection Inserts inside the base of the mold should be available in the info card accompanying the mold kit. This will make the process of identifying the position of the implant type connection inserts easy for your assistant.

Step 4

Custom Healing Abutment Fabrication Process

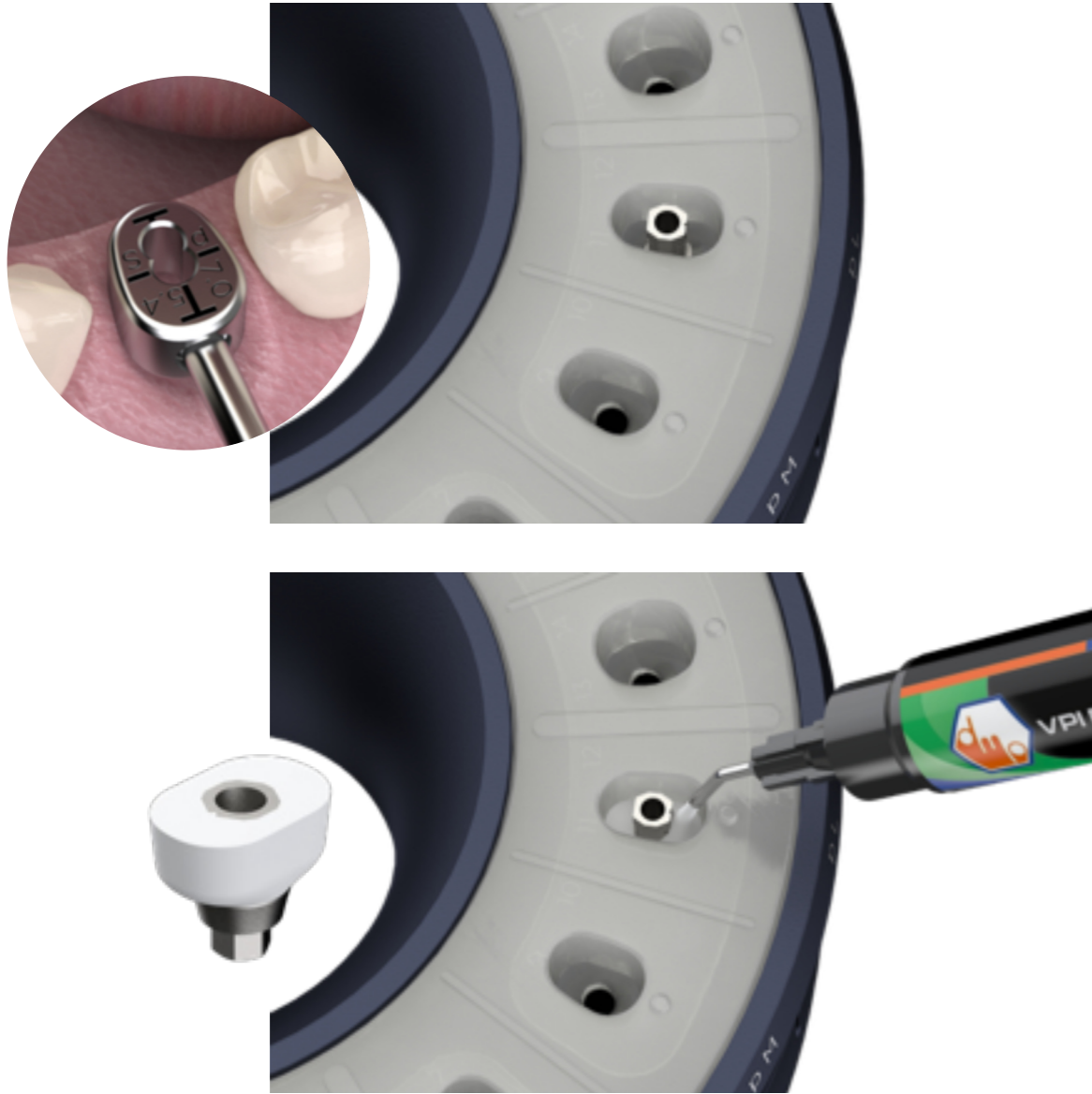

The assistant installs a temporary abutment in the well of the mold with corresponding code (E.g pS) to the one of the anatomical shape tab of the guide (E.g pS).

He/She then introduces suitable composite material in the open space and light cures in one or more increments.

He/She then un-installs the created custom healing abutment and proceeds with polishing of the composite surface and proper disinfection.

The process of custom healing abutment fabrication can be done after the consultation appointment, or even at surgery since it only requires approximately 4 minutes to be completed.

Step 5

Duplicate Impression Post Fabrication Process

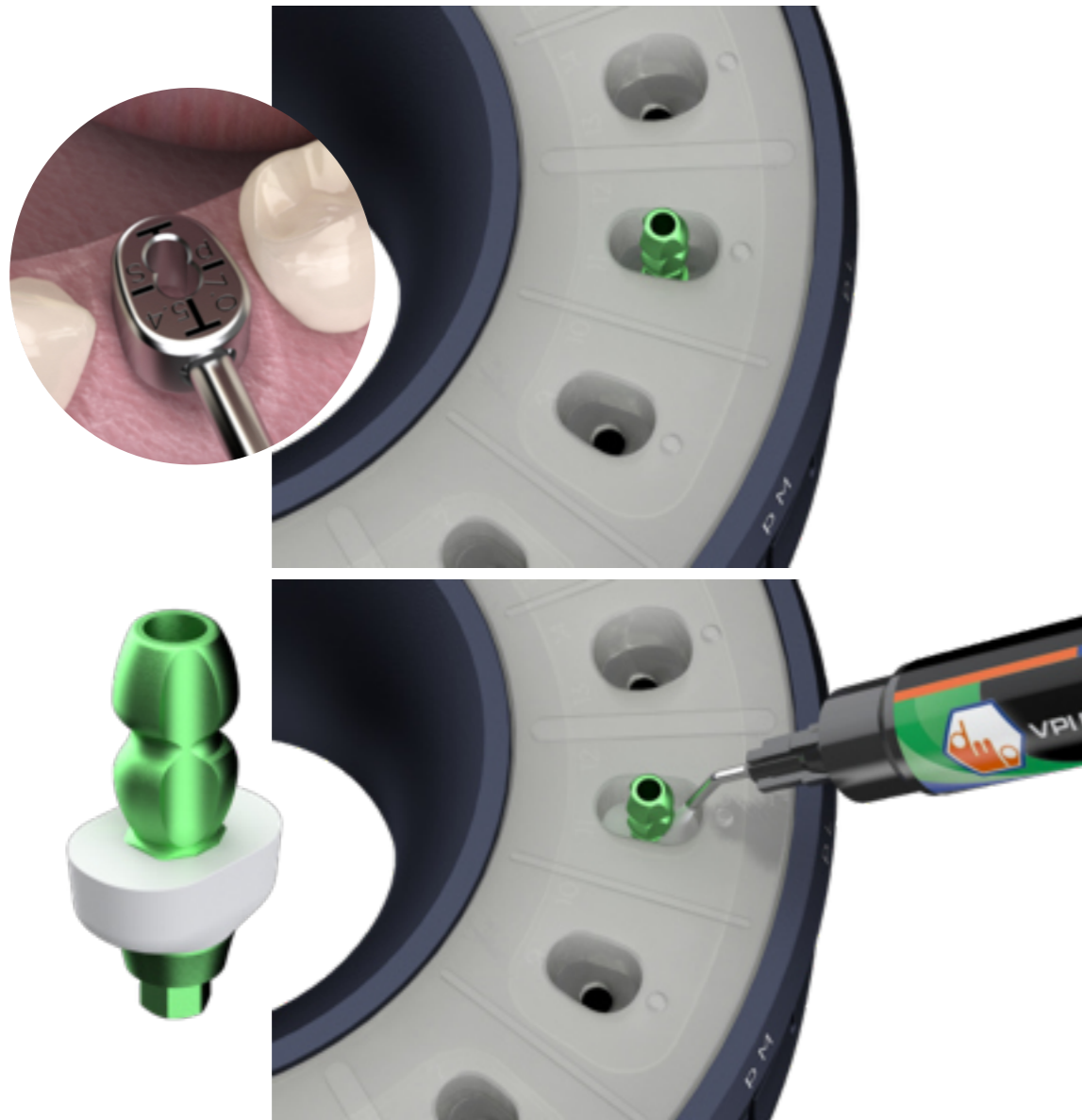

The assistant installs a stock impression post in the same well of the mold that was used for the fabrication of the custom healing abutment (E.g pS).

He/She then introduces suitable composite material in the open space and light cures in one or more increments.

He/She then un-installs the created duplicate impression post and proceeds with polishing of the composite surface and proper disinfection.

The process of duplicate impression post fabrication can be done after the consultation appointment, or at surgery, or even before the impression stage, since it only requires approximately 4 minutes to be completed.

Step 6

Custom Healing Abutment Installation Process



Install the custom healing abutment into the implant, utilising the retention screw available with the temporary abutment used.

Evaluate clinically and radiographically proper fit with the implant.

Fill the screw access bore with a first layer of sterile teflon tape, or other suitable material.

Fill the remaining open space of the screw access bore with composite material and light cure.

Evaluate proper occlusal clearance of the custom healing abutment and if necessary reduce its height.

This process can be performed at time of implant placement (One stage protocol), or at stage of implant uncovering.



VP INNOVATO HOLDINGS

Impression Stage



Step 1

Custom Healing Abutment Un-installment

Remove the composite and sterile teflon tape from the screw access bore.

Un-screw and un-install the custom healing abutment.



Step 2

Duplicate Impression Post Installation Process / Impression



Install the duplicate impression post following the same orientation as per the previously installed custom healing abutment.

Proceed with the impression process utilising your preferred impression technique.

This process can be performed utilising closed or open tray impression posts and indirect or direct impression technique.

It is advisable, in case of multiple implants, to immediately replace the uninstalled custom healing abutment with its duplicate impression post before proceeding to the next implant. This will ensure proper support of the emergence profile and will increase your available working time.

Step 3

Working model Fabrication Process



The Lab Technician proceeds with working model fabrication as per normal practices.

The generated custom gingival emergence and cervical profile has been accurately recorded and provides the foundation for the design and fabrication of an aesthetically pleasing and biologically sound prosthesis.

The Lab Technician should utilise the generated emergence and cervical profile as a guide for the design of the submerged area of the prosthesis.

It is advisable that the submerged area of the prosthesis is fabricated by biocompatible materials (Titanium and/or Zirconium dioxide) so that it can provide the foundation for a long term stable result.



VP INNOVATO HOLDINGS

Duplication Stage

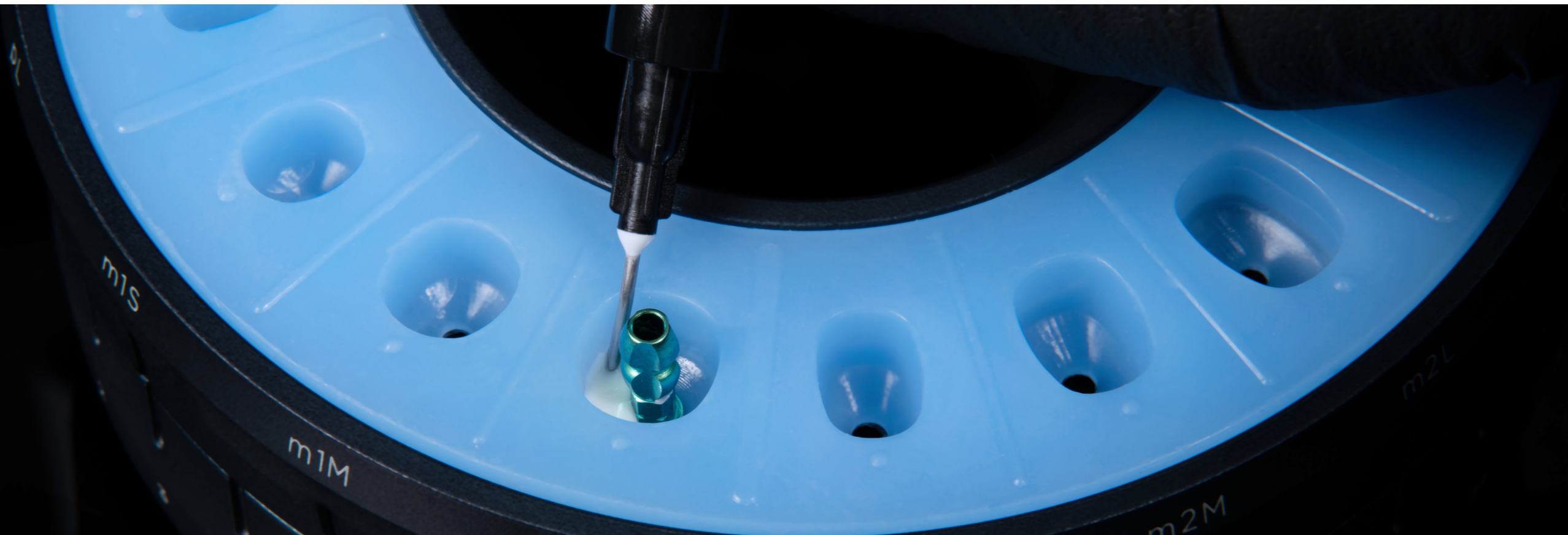

Duplication Stage



This stage is only needed in case:

a) You modify the sub-merged area of the custom healing abutment in order to fit the needs of your case.

b) You utilise a temporary prosthesis and immediate loading protocols, without the use of the custom healing abutment produced by the Cervico system.

Modified Custom Healing Abutment



Duplicate Impression Post

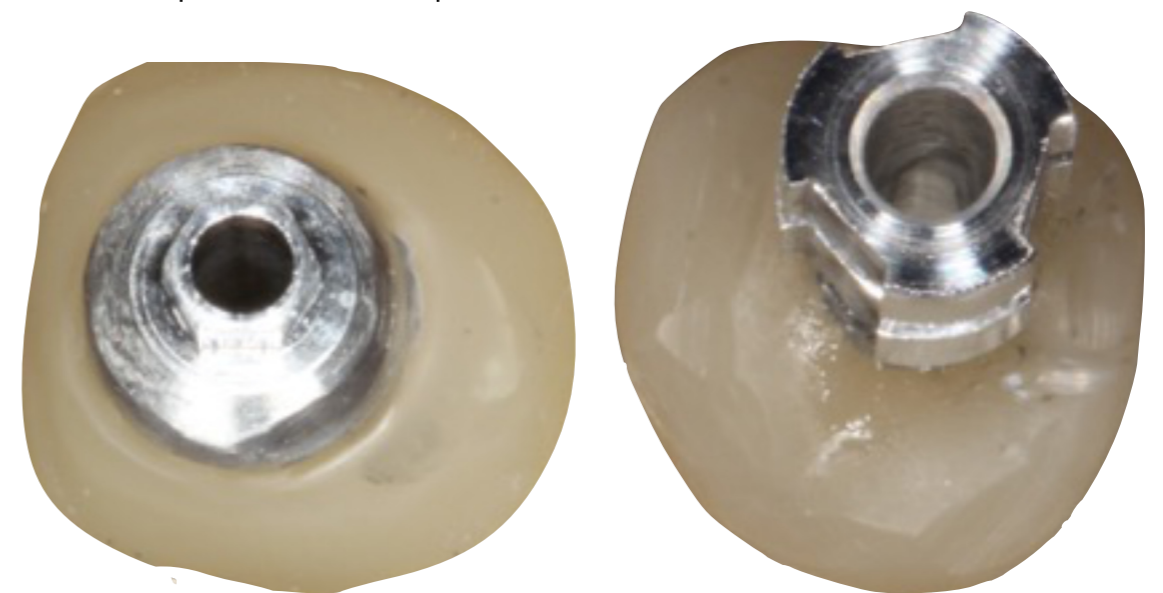

Step 1

Duplication Stage

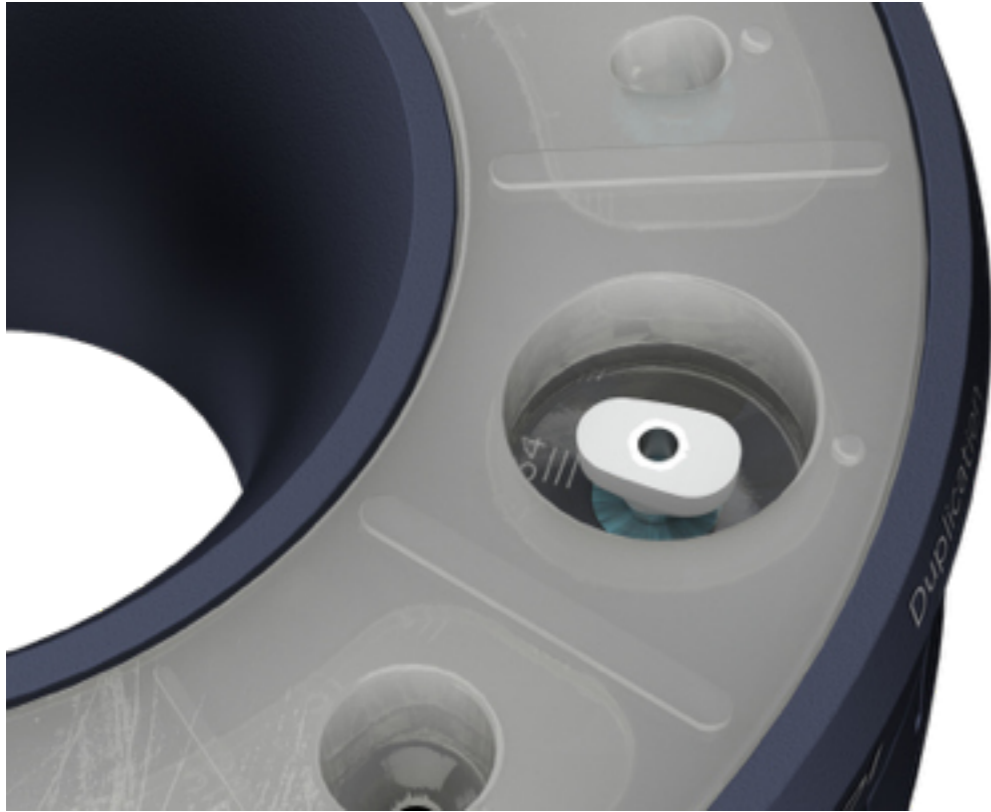

Rotate the top ring of the mold until the duplication well is aligned to the desired VPI Prosthetic Connection Insert present in the base of the mold.

Apply vaseline or other lubricant agent on the inner side walls of the duplication well.

Install the modified custom healing abutment, or the temporary prosthesis in the duplication well.

This process can be performed just before final installation of the modified custom healing abutment or temporary prosthesis to the implant (Preferable); Or just before the impression stage.

Step 2

Duplication Stage

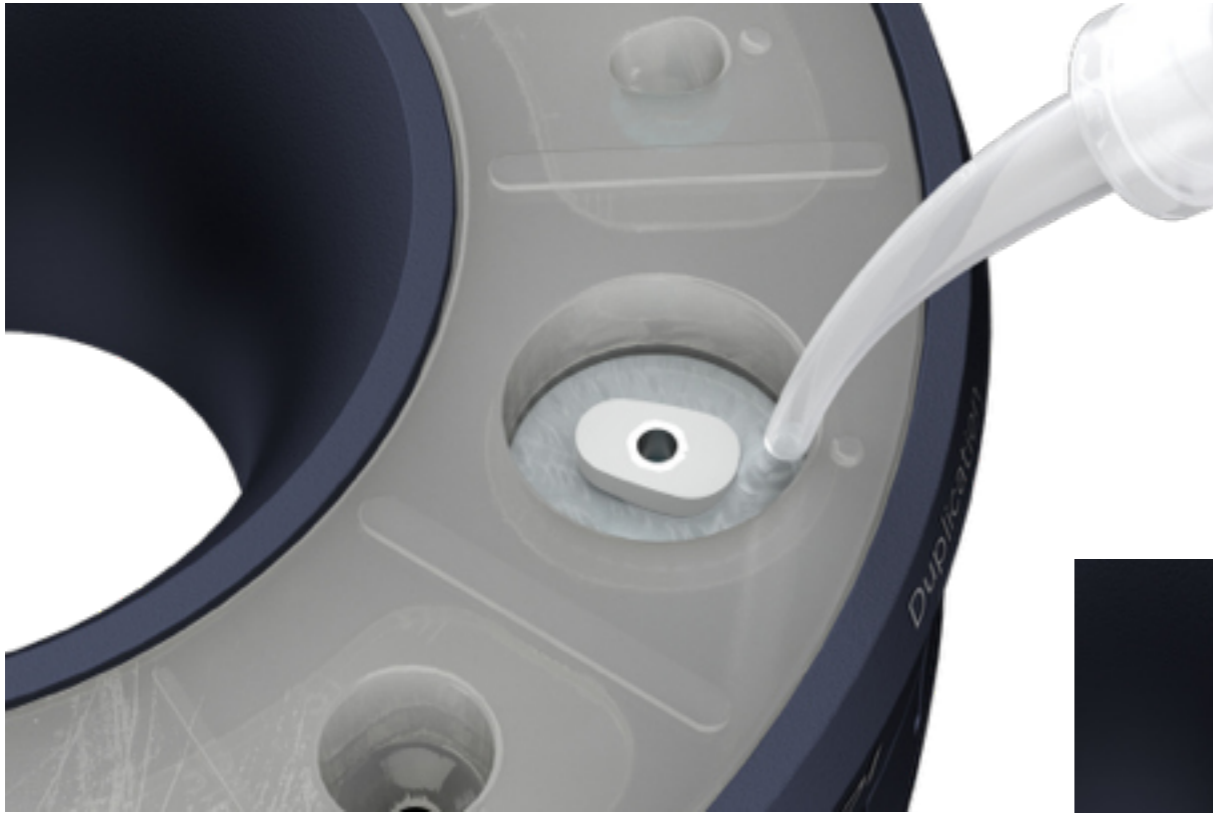

Introduce clear silicone impression material in the available open space and let it set according to the manufacturer's instructions.

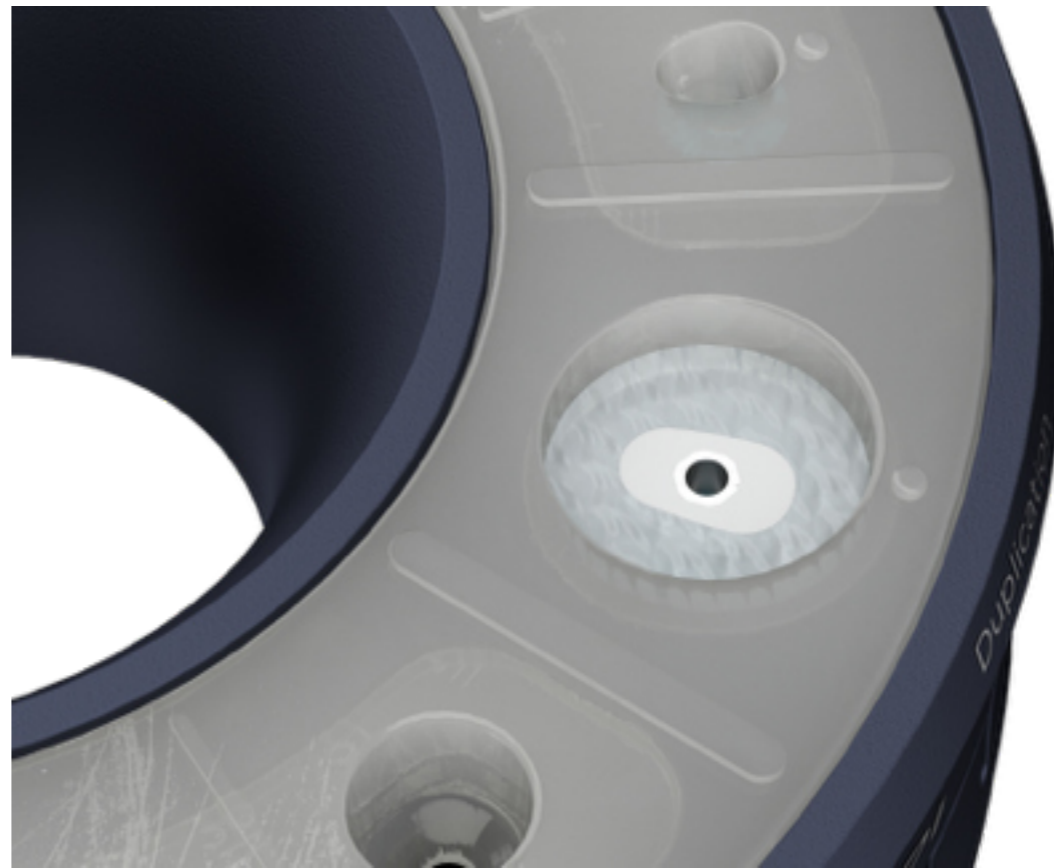

Step 3

Duplication Stage

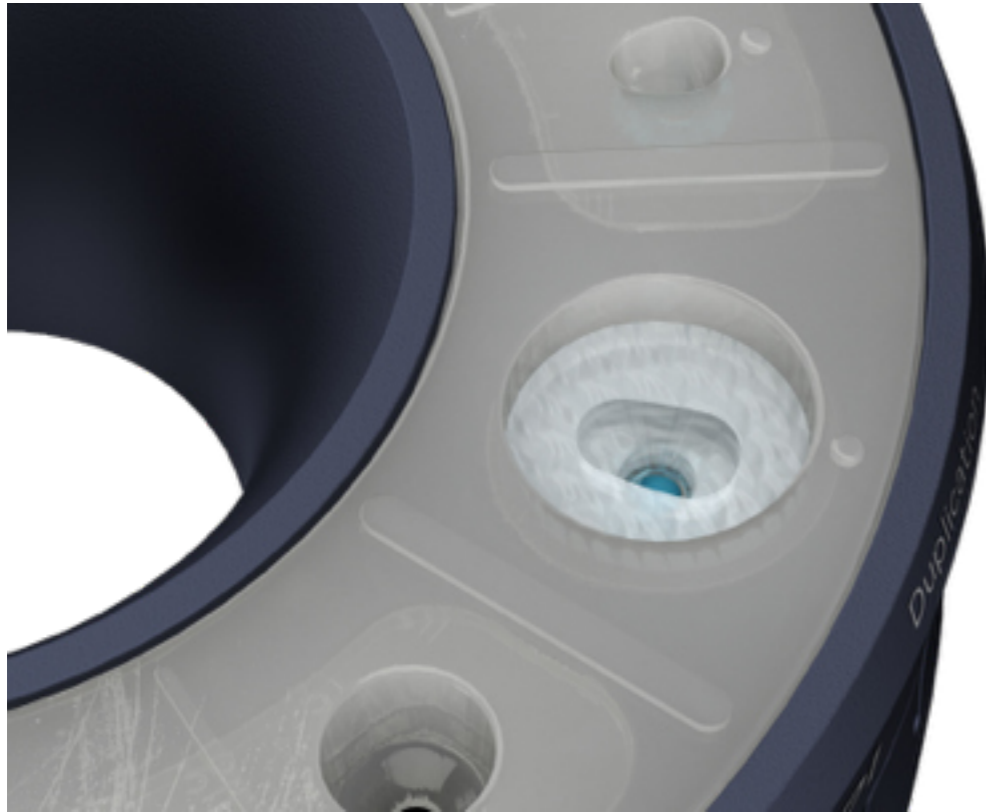

Un-install the modified custom healing abutment, or the temporary prosthesis from the duplication well.

Install in the duplication well a suitable stock impression post.

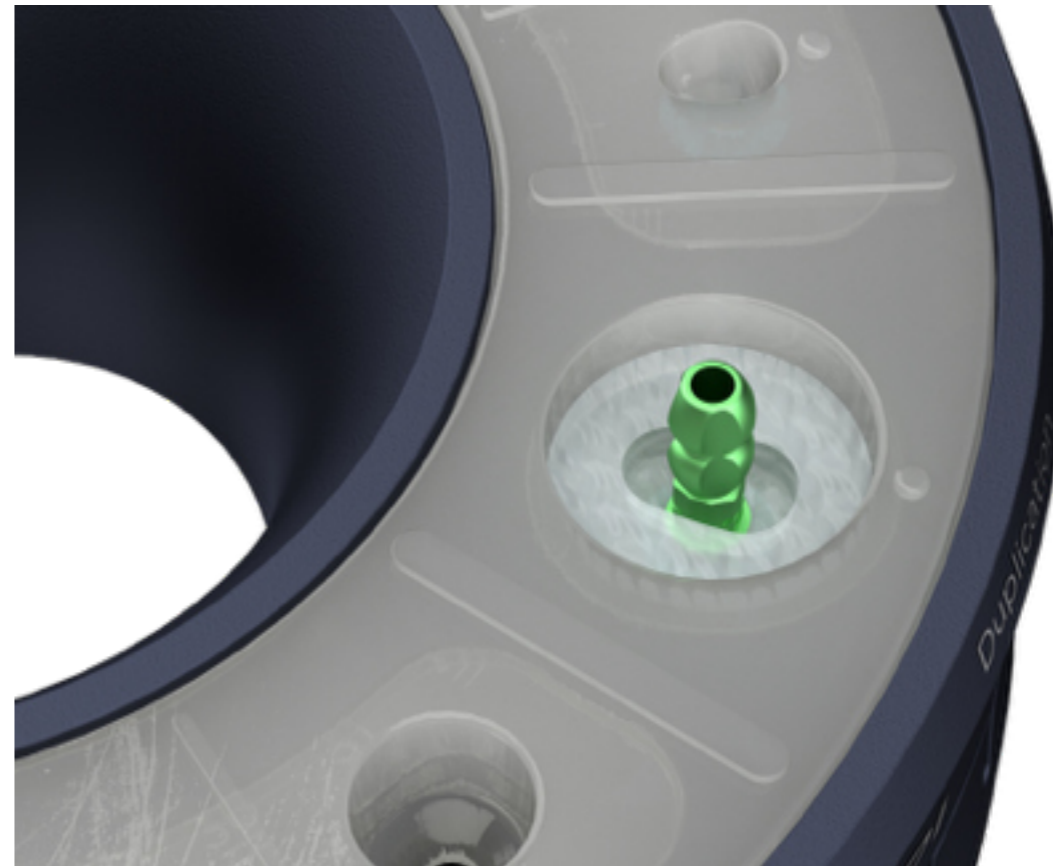

Step 4

Duplication Stage

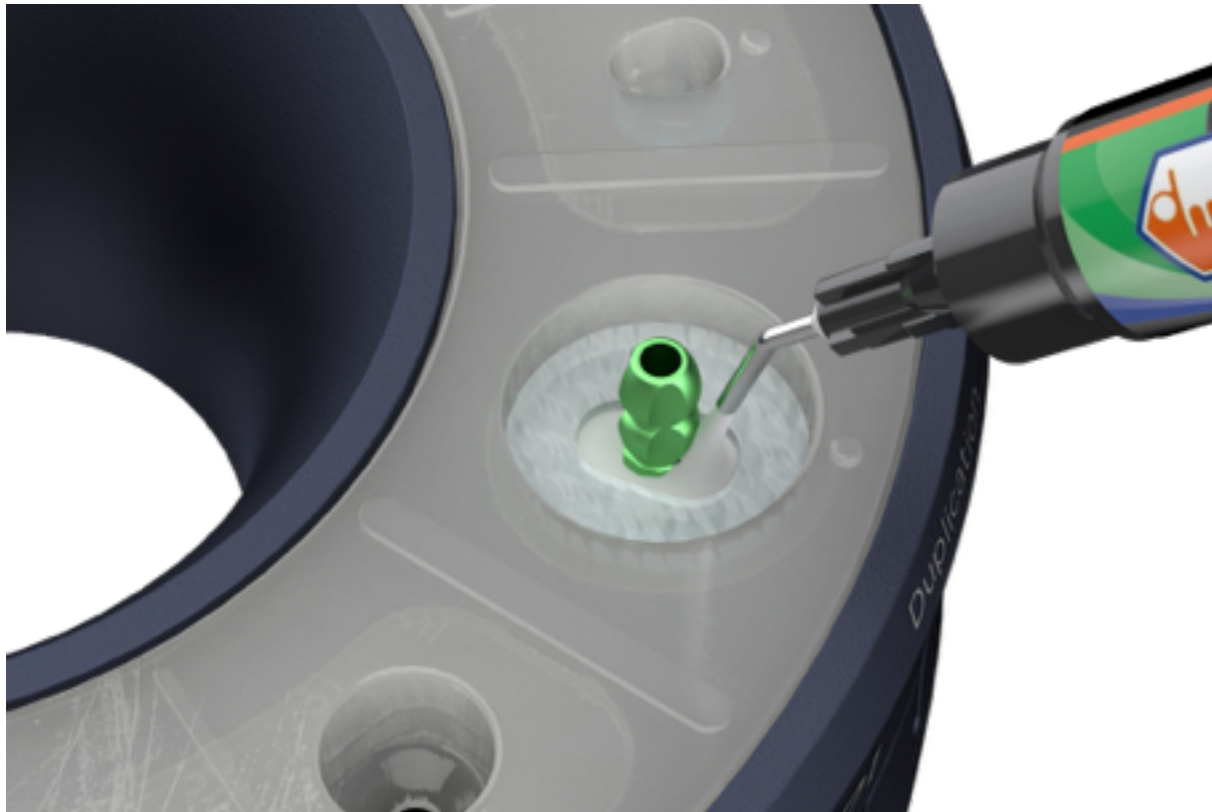

Fill the available open space with suitable composite material and light cure in one, or more increments*.

Un-install the generated duplicate impression post from the duplication well.

The generated custom impression post is now the exact duplicate of the modified custom healing abutment, or temporary prosthesis at least at their sub-merged portion.

Remove the silicone impression material from the duplication well utilising a cotton plier, or other suitable instrument.

*In case you utilise a non-clear (coloured) silicone impression material, it is advisable to fill the space with composite material and light cure in small increments. This will ensure proper light curing of the composite material.



VP INNOVATO HOLDINGS

Immediate loading



Immediate loading protocol



The custom healing abutments generated by the Cervico mold can be prepped intra-orally at their supra-gingival portion following same methodology as per natural teeth preparation protocols.

This way you can transform your custom healing abutment to a custom temporary abutment capable of supporting a temporary prosthesis.

Step 1

Immediate loading protocol



The steps of site evaluation, cervical profile selection and custom healing abutment and duplicate impression post fabrication process are the same as per normal protocols previously described.

In case of modification of the custom healing abutment to a custom temporary abutment suitable to support a temporary prosthesis in immediate loading protocols the only necessary modification is the following:

Please fill the complete height of the well of the mold with composite material so that the generated custom healing abutment has the biggest height possible. Any necessary height adjustments can be done after it is installed into the implant for evaluation and modification.

Step 2 Immediate loading protocol

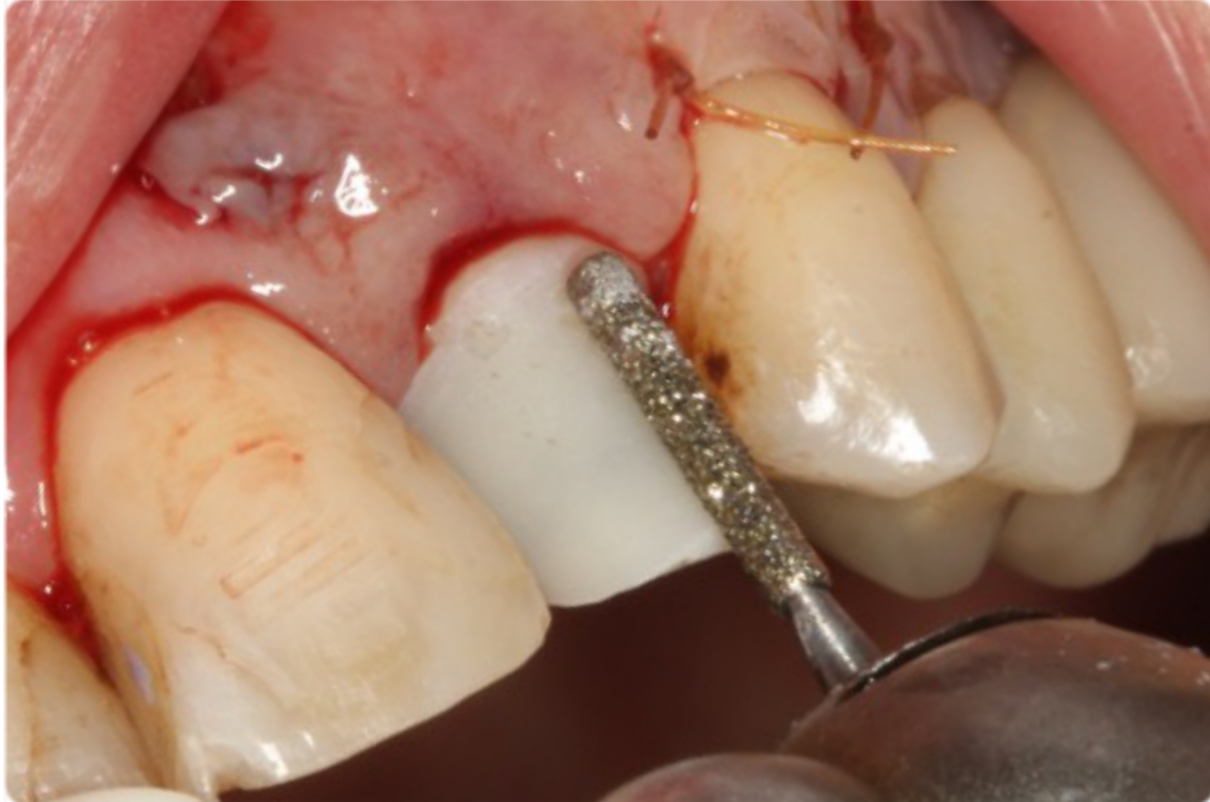

Install the custom healing abutment into the implant and proceed with supra-gingival preparation following the same protocol/methodology as per natural tooth preparation for crown or veneer prosthesis.

Since the sub-merged area of the custom healing abutment is not modified the duplicate impression post produced by the same well of the mold can be utilised at time of impression and the duplication process is not necessary.

Step 3

Immediate loading protocol



You can proceed with impression of the custom temporary abutment in order for the lab to fabricate a temporary prosthesis.

Or, you can adjust a prefabricated temporary prosthesis directly onto the custom temporary abutment.

It is advisable that you limit the shoulder of your preparation at the supra-gingival area. This will eliminate the need for generating the duplicate impression post through the duplication process. Also, this will minimise the chance for cement escape in the submerged area if the temporary prosthesis is chosen to be cement retained.